

Modular and Off-Site Construction

lindapter[®]

Technical Innovation in
Steelwork Connections



Welcome

lindapter[®]

Safely securing steelwork
for over 80 years

Lindapter fixings are specified around the world for permanent and temporary connections in a variety of modular and off-site construction applications. Whether securing structural steel sections, cable management systems or constructing modular buildings, Lindapter has a proven, accredited and adjustable connection that will allow fast alignment on-site.

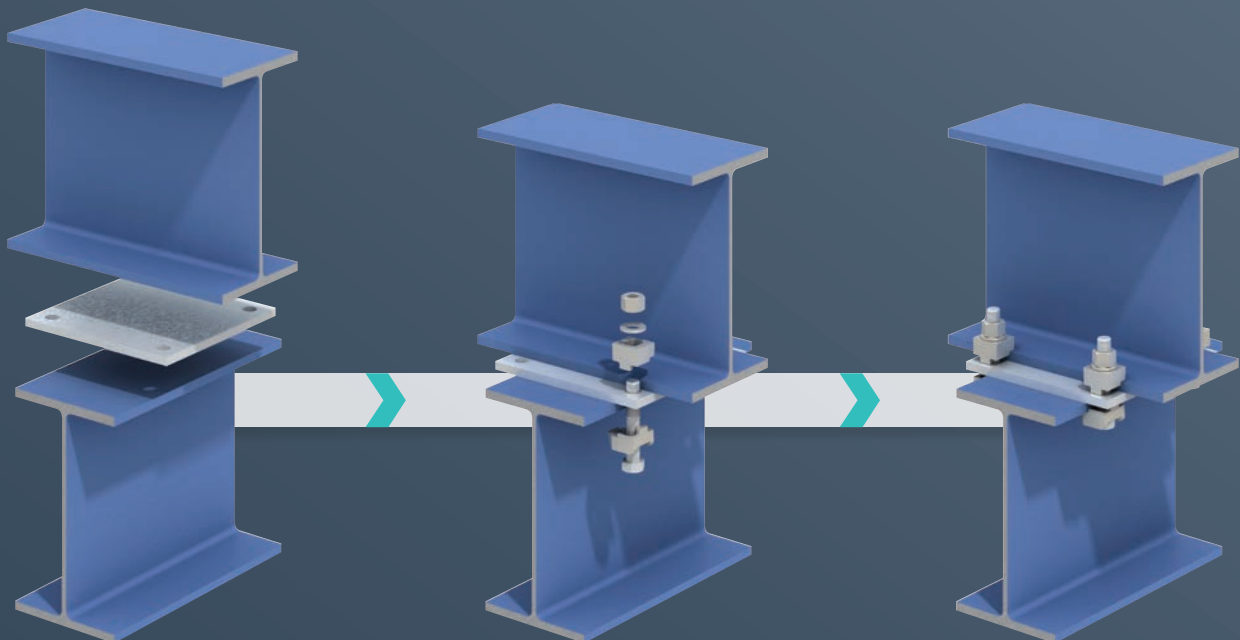

WHY USE LINDAPTER CONNECTIONS IN MODULAR AND OFF-SITE CONSTRUCTION?

Lindapter is a world leader in the design and manufacture of steel-to-steel connections that eliminate the need for on-site drilling or welding. The concept allows a safer, faster installation and less work at height compared to traditional methods, which significantly reduces costs.



Faster installation
Lower labour costs



No steelwork damage
No site drilling or welding



Easy to install & adjust
Accurate positioning



Durable
High strength connections



Reliable
Independently approved



Hassle-free solutions
Free detailing service

CONTENTS

| | |
|------------------------------------|---|
| Connections for | Project Experience |
| ■ Modular Units 4 | ■ Case Studies 8 - 9 |
| ■ Cable Management Systems 4 | Transportation 8 |
| ■ Pre-Fabricated Balconies 5 | Lifting 8 |
| ■ Securing Steel Framework 5 | Framework 8 |
| ■ Lifting Beams 6 | Connecting Modules 8 |
| ■ Transportation 6 | Lindapter Accreditations & Service |
| ■ Steel Frames 7 | ■ Approvals 10 |
| ■ Rooftop Plants 7 | ■ Technical Support 11 |

PROJECT EXAMPLE: SPURN DISCOVERY CENTRE, UK

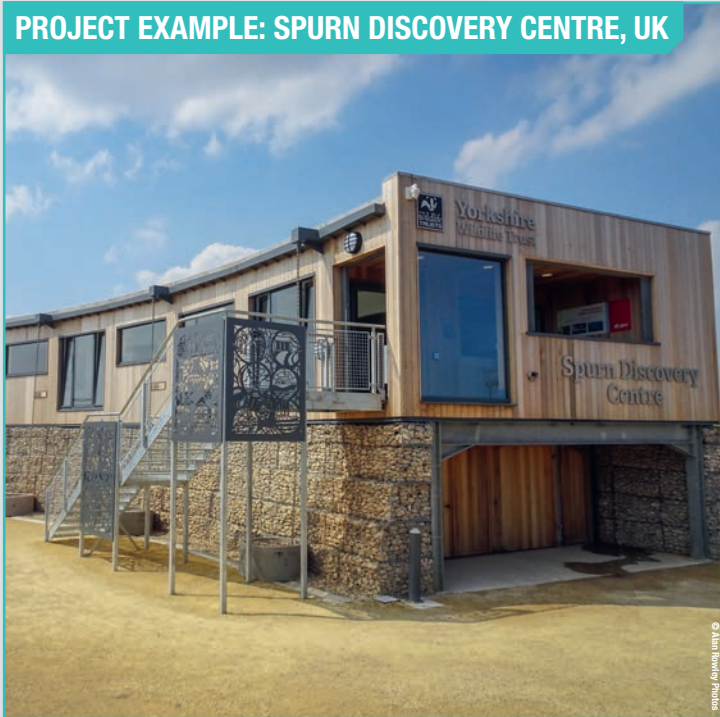

Lindapter Hollo-Bolts were used to connect the SHS (Structural Hollow Section) framed modular rooms together.

Find out more on page 9 or visit www.Lindapter.com to see other project examples.



Typical Applications

CONNECTING MODULAR UNITS

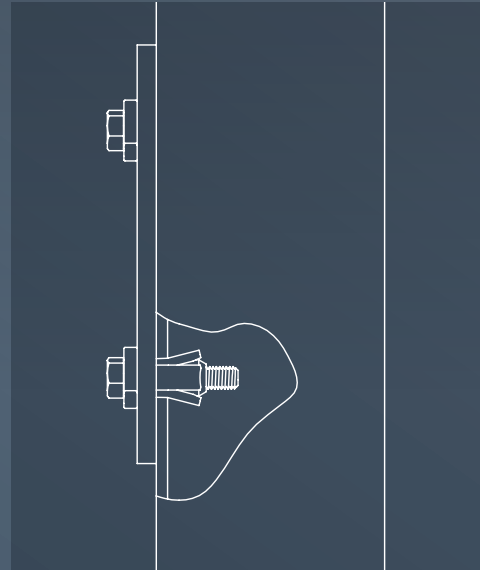
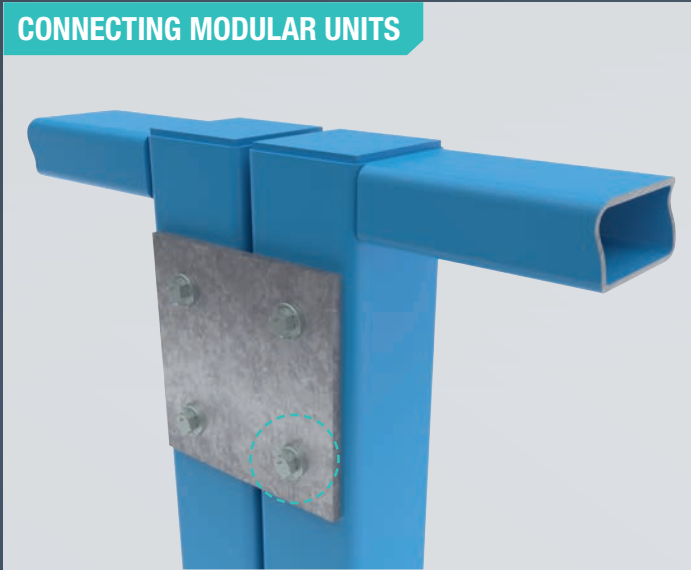

Hollo-Bolts and location plates connect the SHS (Structural Hollow Section) framework of adjoining modules together. It is a popular connection method because the Hollo-Bolt has a high strength capacity and range of independent approvals including the CE mark approval and the ICC-ES approval for resistance to wind loads and seismic loads (contact Lindapter for details).

CABLE MANAGEMENT SYSTEMS

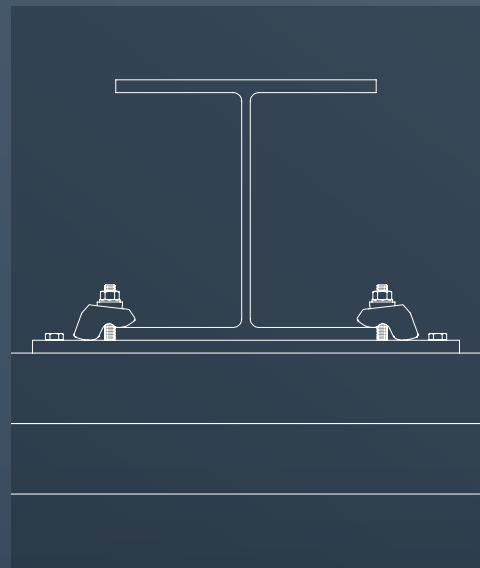
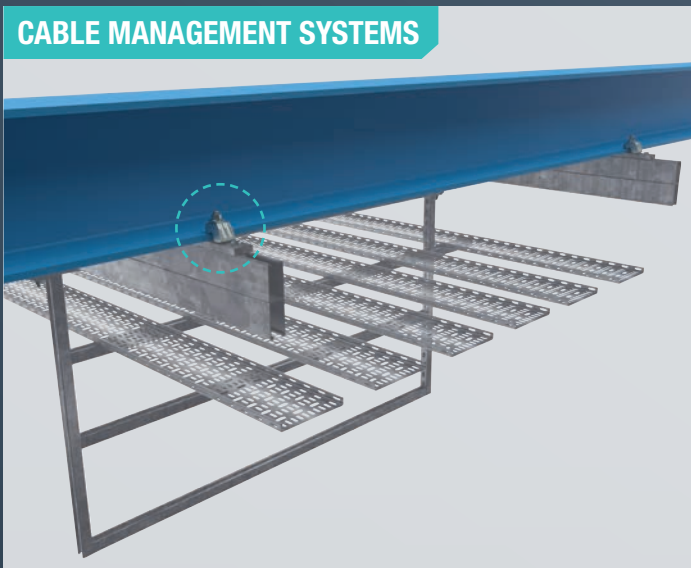

Lindapter CE Marked clamping systems are used to secure the framework for cable tray systems, which are often shipped to site as complete assemblies. Contractors then use Lindapter clamps to loosely attach the cable management systems to the structure, aligning them into position, before tightening the clamps with standard hand tools to complete the installation.

PRE-FABRICATED BALCONIES

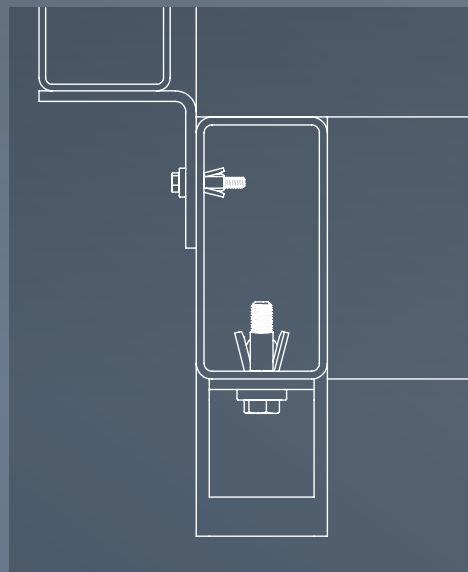
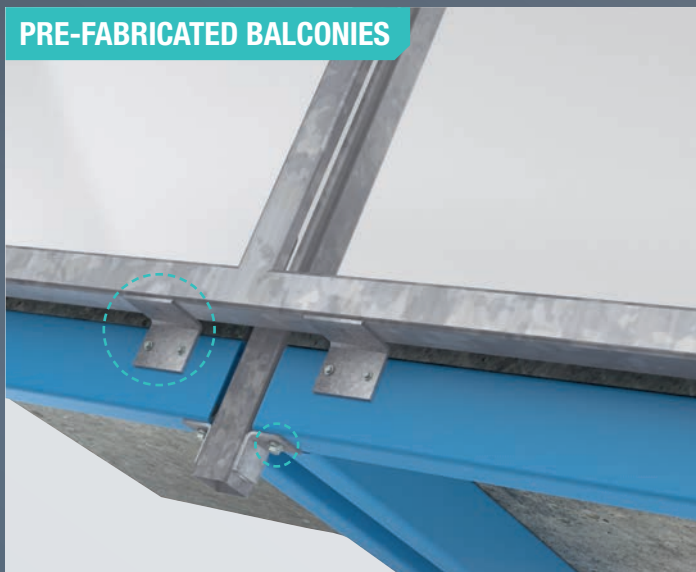

Hollo-Bolts by Lindapter provide a quick and reliable way for contractors to attach balconies to new or existing buildings. Hollo-Bolts are used as splice connections for the structural hollow sections which are positioned vertically against the building and then Hollo-Bolts connect the balcony framework to the structural hollow section.

SECURING STEEL FRAMEWORK

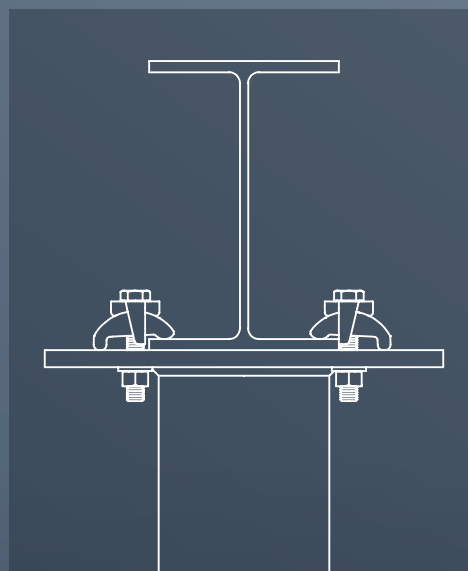

Lindapter Girder Clamps are often specified for securing an I-Beam steel frame to ground screws to create a supporting framework for modules to be attached onto. Lindapter's clamping method allows the contractor to quickly position the beams before tightening the clamps with standard hand tools. All applications shown in this brochure represent actual projects. See page 9 for an example of framework connections.

Typical Applications

LIFTING BEAMS

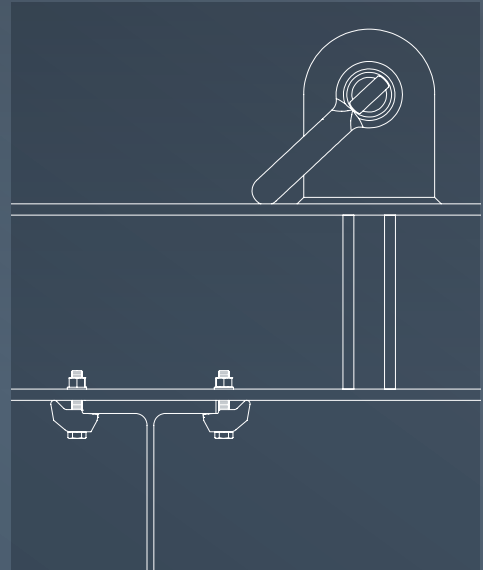
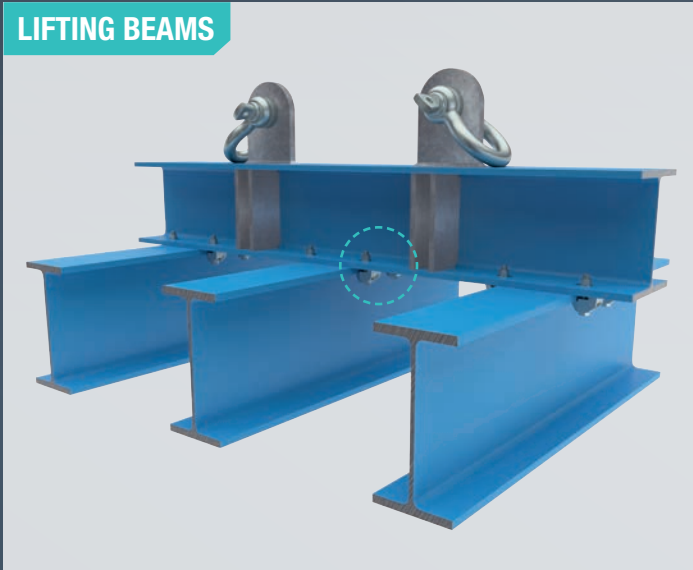

Lindapter fixings can be used to connect lifting brackets to pre-built modules such as bridge decks so that the contractor can quickly and safely hoist large modules up to the place of installation, without damaging the material or its coatings. Once it is secured in position, the contractor reverses the process and simply unclamps the Lindapter fixings to release the lifting beam. Further details of this application can be found on page 8.

TRANSPORTATION

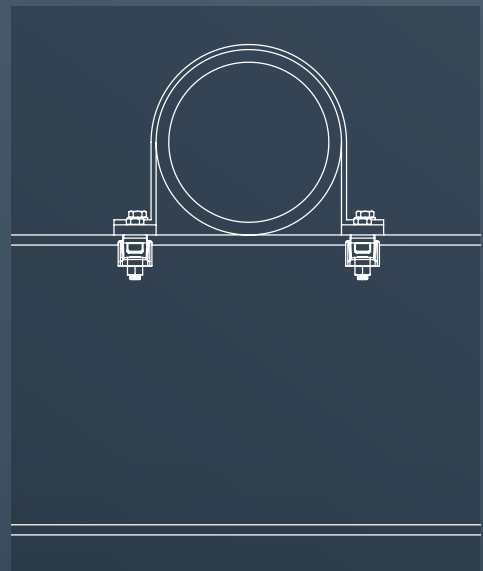
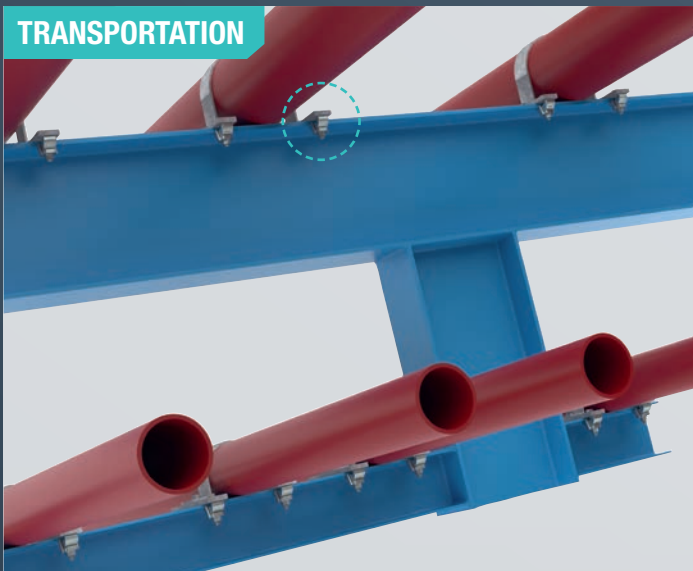

Adjustable clamps allow contractors to quickly secure modules into position during transport without damaging the steelwork or its coatings. The clamping systems are made from high strength materials and hot dip galvanised to ensure protection against harsh weather conditions. Once arriving on-site, the process is simply reversed by unclamping the Lindapter clamping systems to release the modules from the vehicle. Project example on page 8.

STEEL FRAMES

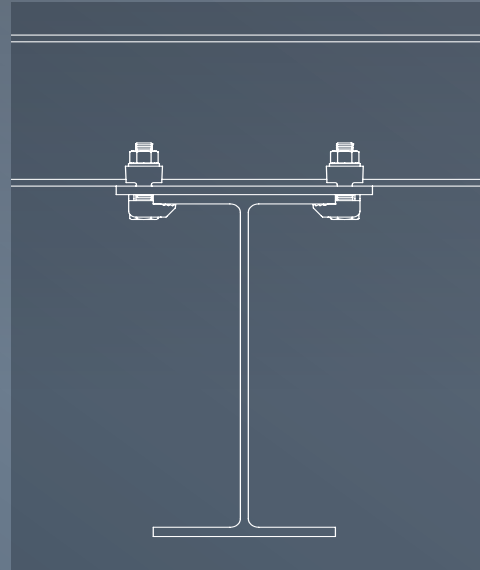
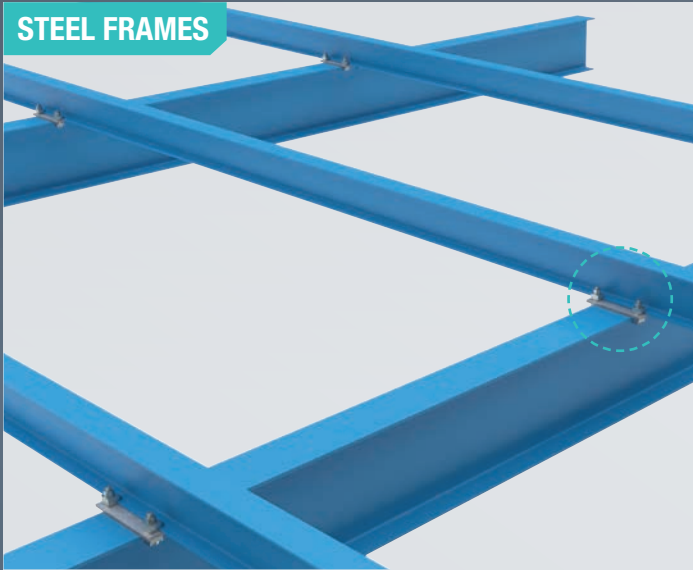

Lindapter's clamping systems can be used to secure the steel framework, including the base frame of modular buildings. The Girder Clamp's adjustability allows the installer to quickly align the steel beams, before tightening the clamps with standard hand tools to complete the installation. The Girder Clamp provides a fast and convenient alternative to drilling and welding on-site, while preserving the integrity of the steelwork.

ROOFTOP PLANTS

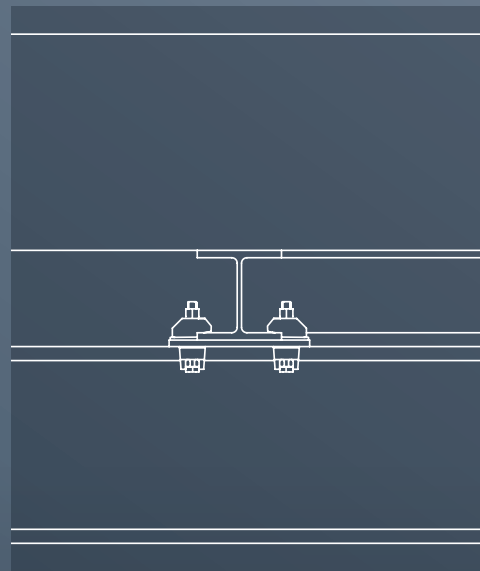
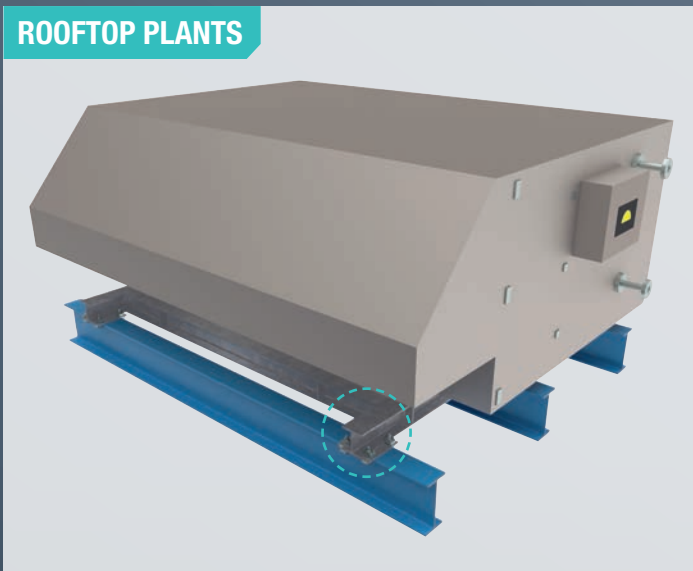

Rooftop plants are shipped to site as complete units and craned up to the roof of the building where they are quickly installed onto a steel frame using Lindapter's clamping systems. The clamp's lateral adjustability provides quick alignment and a simple installation process using just standard hand tools. The clamps also allow the units to be easily removed or adjusted for repairs and maintenance at a later date.

Project Experience

1

TRANSPORTATION



ESCRAVOS GAS TO LIQUID PROJECT
Nigeria

Lindapter Type LR clamps were used to secure the pipework to a supporting framework during transportation of the modules from the place of manufacture in the UAE to the project location in Nigeria.

Lindapter clamps securely held the pipes in position, without the need for drilling or welding. They were chosen because of their adjustability which ensured the pipes could be quickly installed and then simply unclamped when they arrived at their destination.

The clamps provide high corrosion protection and ensure that the integrity of the steel and its coatings remain intact. This was of paramount importance due to the harsh offshore environment.



2

LIFTING



A75 AUTOROUTE
France

Lindapter fixings were used to create lifting beam brackets for lifting bridge sections onto the A75 autoroute in France.

To minimise the construction process on-site, the contractor pre-fabricated some elements of the bridge that were assembled together before arriving to where the new bridge was going to be built.

Once the shipment arrived at the location, the modules were quickly and safely hoisted up onto the work area where the sections were then unclamped without damaging the steel or its coatings.

The installer benefited from the convenient adjustability of the clamps and the simple disassembly of the lifting equipment.



3

FRAMEWORK



NORDSTADTSCHULE
Pforzheim, Germany

Lindapter Type F9 clamps were used to secure a steel framework to the ground screws.

During the renovation of a school in Pforzheim, Germany, a temporary structure was constructed. Lindapter's clamping method allowed the contractor to quickly position the framework before tightening the clamps with standard hand tools to complete the installation process.

When the renovation was complete, the temporary school was quickly disassembled. The modular rooms were lifted off the framework and the steel was unclamped from the ground screws. Type F9 clamps ensured the steel framework remained intact so the contractor could use the steel again.



4

CONNECTING MODULES



SPURN DISCOVERY CENTRE
East Yorkshire, UK

Hollo-Bolts and steel plates were specified for connecting the Structural Hollow Section (SHS) framework of the rooms together.

The hexagonal head, HDG Holo-Bolt was selected because of its high strength capacity and its range of independent technical accreditations, including the CE mark.

The Holo-Bolt allowed a fast and convenient installation process from the inside of the modules using just standard hand tools, which resulted in an efficient construction schedule.

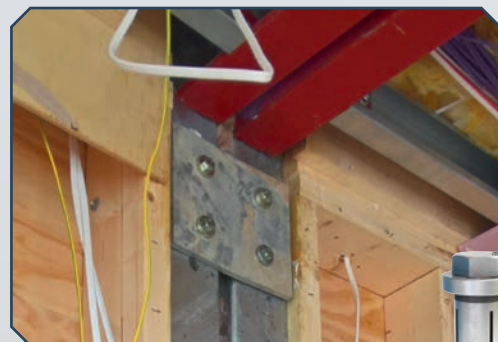

Accreditation & Service

Independent Product Approvals

Lindapter has manufactured to the highest standard for over 85 years, earning a multitude of independent approvals and a reputation synonymous with safety and reliability. Current accreditations include:

CE Marking provides additional assurance that a product complies with the Construction Product Regulation and will perform as stated in the corresponding Declaration of Performance (DoP). DoPs list Characteristic Resistances for use when designing connections to Eurocode 3. For more information, visit www.Lindapter.com/About/CE



Lloyd's Register Type Approved products have been subjected to tensile, frictional, vibration and shock tests, witnessed and verified by Lloyd's Register.



ICC-ES approved Hollo-Bolts (hexagonal head, HDG) are verified to resist seismic and wind loads in all Seismic Design Categories (A to F).



TÜV NORD is the certifying authority for safety, quality and environmental protection in Germany.



Factory Mutual, an American insurance organisation, offers an approval which is recognised by the fire protection industry worldwide.



Loss Prevention Certification Board (LPCB) is a renowned International Certification body in the field of security and fire protection.



Verband der Schadenversicherer is a leading German independent testing institutions for products used in fire protection applications.



Quality and Environment

Accredited to **ISO 9001** since 1986, Lindapter strictly enforces a quality management system that includes vigorous product testing to ensure consistently high manufacturing standards. Lindapter also operates an **ISO 14001** certified environmental management system and constantly monitors and improves aspects of the business that may have an impact on the environment, including the use of natural resources, the handling and treatment of waste and energy consumption.



Traceability

As part of Lindapter's ISO 9001 quality management system and in compliance with the Construction Products Regulation, Lindapter operates a comprehensive Factory Production Control system that ensures traceability of all Lindapter products throughout the manufacturing process.

Associations

Lindapter is a member of the following: British Constructional Steelwork Association, The Steel Construction Institute, American Institute of Steel Construction and Southern African Institute of Steel Construction.



The Lindapter Service

Experienced Engineers offer an unrivalled support service, including free design and bespoke product development. Lindapter's philosophy is to deliver the highest quality at every stage of the service, from initial design through to installation guidance, see below:

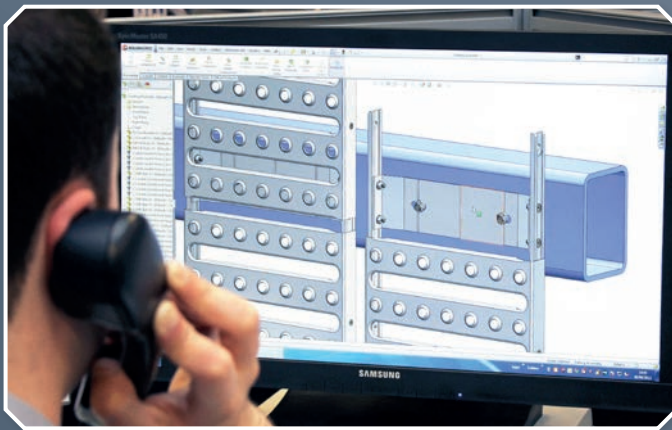
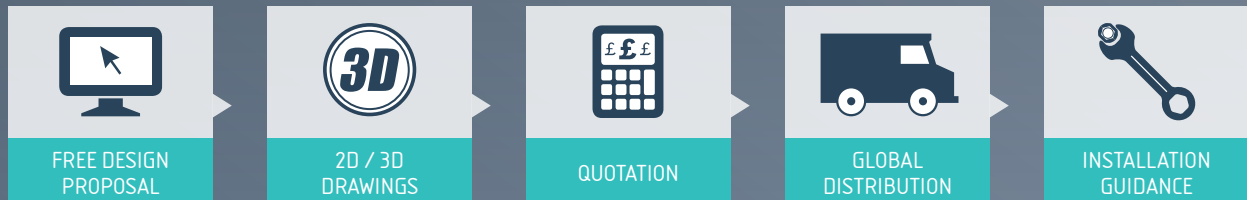

You will receive...

- ✓ Specialist advice from experienced Engineers
- ✓ Free connection design based upon your requirements
- ✓ Bespoke drawings delivered in 2D and interactive 3D formats
- ✓ CAD files that can be imported into all major software applications
- ✓ Contractor training and on-site visits (where required)

Engineered Solutions

Lindapter's Research & Development facility and unique expertise facilitates a bespoke product development service, referred to as 'Engineered Solutions'.

Supported by the latest technology including 3D printing, rapid prototyping with the aid of two in-house 1000kN hydraulic test machines (pictured right) and finite element analysis, Lindapter's Engineers can develop solutions that satisfy your connection demands.



Ask Lindapter to design a solution to your requirements. Call **+44 (0) 1274 521444** or email **support@Lindapter.com**



Disclaimer Lindapter International supplies components in good faith, on the assumption that customers fully understand the loadings, safety factors and physical parameters of the products involved. Customers or users who are unaware or unsure of any details should refer to Lindapter International before use. Responsibility for loss, damage, or other consequences of misuse cannot be accepted. Lindapter makes every effort to ensure that technical specifications and other product descriptions are correct. 'Specification' shall mean the specification (relating to the use of the materials) set out in the quotation given by the Seller to the Buyer. Responsibility for errors or omissions cannot be accepted. All dimensions stated are subject to production tolerances - if in doubt please check with Lindapter. In the interests of improving the quality and performance of Lindapter products, we reserve the right to make specification changes without prior notice.

© Lindapter International 2018 LINDAPTER, HOLLO-BOLT, LINDIBOLT, FLOORFAST, GRATE-FAST etc., are all registered trademarks. Lindapter may also have trademark rights in other terms used herein.



lindapter[®]

**Ask Lindapter to design a solution
to your connection requirements:**

Tel: +44 (0) 1274 521 444

Fax: +44 (0) 1274 521 130

General Enquiries: enquiries@Lindapter.com

Technical Support: support@Lindapter.com